





# TEST REPORT

<b>Kunde:</b> <i>Client:</i>	Shenzhen Goldenlux Co.,Ltd
<b>Adresse:</b> <i>Address:</i>	3/F Building 1, Bei Fang Yong Fa Industrial Area, Sha Jing Town, Bao'an District, Shenzhen, China
<b>Hersteller:</b> <i>Manufacturer:</i>	Shenzhen Goldenlux Co.,Ltd
<b>Adresse:</b> <i>Address:</i>	3/F Building 1, Bei Fang Yong Fa Industrial Area, Sha Jing Town, Bao'an District, Shenzhen, China
<b>Name der Marke:</b> <i>Brand Name:</i>	
<b>Beschreibung des Produkts:</b> <i>Product Description:</i>	LED High Bay
<b>Modelle:</b> <i>Models:</i>	See model list on page 2
<b>Bewertung:</b> <i>Rating:</i>	AC 220-240V, 50/60 Hz, Max.500W
<b>Verfahren:</b> <i>Method:</i>	Clause 9 of IEC 60598-1:2014+A1:2017
<b>Prüfergebnis*:</b> <i>Test result*:</i>	Pass

<b>Datum der Prüfung:</b> <i>Date of Test:</i>	<b>Datum der Emission:</b> <i>Date of Issue:</i>	<b>Klassifizierung:</b> <i>Classification:</i>	<b>Gegenstand der Prüfung:</b> <i>Test item:</i>
2021-08-16~2021-08-20	2021-08-20	Commission Test	IP65 Test

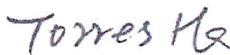
**Prüflabor (Testlabor) / Testing Laboratory:**  
Shenzhen Southern LCS Compliance Testing Laboratory Ltd.

<b>Test von/Test by:</b>  Anther Ruan/ Project Engineer	<b>Check von/Check by:</b>  Torres He/ Director	<b>Genehmigt von/Approved by:</b>  Jesse Liu/ Manager
--	--	--

**Dieser Prüfbericht bezieht sich nur auf das o.g. Prüfmuster und darf ohne Genehmigung der Prüfstelle nicht auszugsweise vervielfältigt werden. Dieser Bericht berechtigt nicht zur Verwendung eines Prüfzeichens.**

*Remark: The duplication of this report or parts of it and its use for advertising purposes is only allowed with permission of the testing laboratory. This report contains the result of examination of the product sample submitted by the appliance. A general statement concerning the quality of the products from the series manufacturer cannot be derived therefore.*



**Equipment used during test:**

ID Number	Instrument	Model/ Type	Calibration Date
SLCS-S-031	Sand and dust test box	SG-500	2021/5/13
SLCS-S-034	IPX5, IPX6 waterproof equipment	JL-1/2	2021/5/13
SLCS-S-135	Digital hygrometer thermometer	HTC-1	2021/5/17
SLCS-S-072	Torque Driver	26RTD	2021/5/13
SLCS-S-073	Hi-pot tester	AN9602M	2021/5/13
SLCS-S-062	Frequency Converter	AN97020TS	2021/5/13
SLCS-S-059	Digital Power Meter	PF9800	2021/5/13

**General product information:**

- Series models have similar appearance except power, LED drivers and size are difference.
- Unless otherwise specified, the model GL-UFO240-N, GL-UFO200-C, GL-UFO200-K and GL-UFO500-J were chosen as representative model to perform all test.

Model list: AC 220-240V, 50/60Hz

Model No.	Power (W)	LED driver	Weight (kg)	Size (mm) (ΦxH)	Series
GL-UFO80-N	80	SS-120CNL-130	2.2	Ø257x110	1
		Xi 100W 0.7-1.0A 1-10V 220-240V RI132S			
GL-UFO100-N	100	SS-120CNL-130	2.2	Ø257x110	
		Xi 100W 0.7-1.0A 1-10V 220-240V RI132S			
GL-UFO120-N	120	SS-150CNL-260	2.7	Ø298x111	
		Xi_150W_1.0-1.5A_1-10V_220-240V_RI132S			
GL-UFO150-N	150	SS-150CNL-260	2.7	Ø298x111	
		Xi_150W_1.0-1.5A_1-10V_220-240V_RI132S			
GL-UFO180-N	180	SS-200CNL-260	3.5	Ø363x115	
		Xi_200W_1.4-2.0A_1-10V_220-240V_RI132S			
GL-UFO200-N	200	SS-200CNL-260	3.5	Ø363x115	
		Xi_200W_1.4-2.0A_1-10V_220-240V_RI132S			
GL-UFO240-N	240	SS-240CNL-260	3.5	Ø363x115	
GL-UFO80-C	80	SS-120CNL-130	1.9	Ø260x112	2
		Xi 100W 0.7-1.0A 1-10V 220-240V RI132S			
GL-UFO100-C	100	SS-120CNL-130	1.9	Ø260x112	
		Xi 100W 0.7-1.0A 1-10V 220-240V RI132S			
GL-UFO120-C	120	SS-150CNL-260	2.3	Ø300x115	
		Xi_150W_1.0-1.5A_1-10V_220-240V_RI132S			





GL-UFO150-C	150	SS-150CNL-260	2.3		
		Xi_150W_1.0-1.5A_1-10V_220-240V_RI132S			
GL-UFO180-C	180	SS-200CNL-260	2.9	Ø350x116	
		Xi_200W_1.4-2.0A_1-10V_220-240V_RI132S			
GL-UFO200-C	200	SS-200CNL-260	2.9		
		Xi_200W_1.4-2.0A_1-10V_220-240V_RI132S			
GL-UFO80-K	80	SS-120CNL-130	1.9	Ø273x121	
		Xi 100W 0.7-1.0A 1-10V 220-240V RI132S			
GL-UFO100-K	100	SS-120CNL-130	1.9		
		Xi 100W 0.7-1.0A 1-10V 220-240V RI132S			
GL-UFO120-K	120	SS-150CNL-260	2.3	Ø308x126	3
		Xi_150W_1.0-1.5A_1-10V_220-240V_RI132S			
GL-UFO150-K	150	SS-150CNL-260	2.3		
		Xi_150W_1.0-1.5A_1-10V_220-240V_RI132S			
GL-UFO180-K	180	SS-200CNL-260	2.9	Ø349x126	
		Xi_200W_1.4-2.0A_1-10V_220-240V_RI132S			
GL-UFO200-K	200	SS-200CNL-260	2.9		
		Xi_200W_1.4-2.0A_1-10V_220-240V_RI132S			
GL-UFO80-J	80	SS-120CNL-130	1.9	Ø260x118	
		Xi 100W 0.7-1.0A 1-10V 220-240V RI132S			
GL-UFO100-J	100	SS-120CNL-130	1.9		
		Xi 100W 0.7-1.0A 1-10V 220-240V RI132S			
GL-UFO120-J	120	SS-150CNL-260	2.3	Ø310x125	
		Xi_150W_1.0-1.5A_1-10V_220-240V_RI132S			
GL-UFO150-J	150	SS-150CNL-260	2.3		
		Xi_150W_1.0-1.5A_1-10V_220-240V_RI132S			
GL-UFO180-J	180	SS-200CNL-260	2.9	Ø350x133	4
		Xi_200W_1.4-2.0A_1-10V_220-240V_RI132S			
GL-UFO200-J	200	SS-200CNL-260	2.9		
		Xi_200W_1.4-2.0A_1-10V_220-240V_RI132S			
GL-UFO240-J	240	SS-240CNL-260	3.5	Ø400x148	
GL-UFO300-J	300	SS-300CA-56BH	3.8	Ø400x148	
GL-UFO400-J	400	SS-480CA-228BH	5.1	Ø490x166	
GL-UFO500-J	500	SS-480CA-228BH	5.1	Ø490x166	



**Test Item:**

Tests for protection against dust-proof: IP6X

**Test Method:**

The tests should be carried out under the standard atmospheric condition.

Temperature range: 20°C to 30°C

Dust-proof luminaires (first characteristic IP numeral 6) shall be tested in a dust chamber similar To that shown in Figure 6, in which talcum powder is maintained in suspension by an air current.

The chamber shall contain 2 kg of powder for every cubic metre of its volume. The talcum powder used shall be able to pass through a square-meshed sieve whose nominal wire diameter is 50  $\mu$ m and whose nominal free distance between wires is 75  $\mu$ m. It shall not have been used for more than 20 tests.

The test shall proceed as follows.

- a) The luminaire is suspended outside the dust chamber and operated at rated supply voltage until operating temperature is achieved.
- b) The luminaire, whilst still operating, is placed with the minimum disturbance in the dust chamber.
- c) The door of the dust chamber is closed.
- d) The fan/blower causing the talcum powder to be in suspension is switched on.
- e) After 1 min, the luminaire is switched off and allowed to cool for 3 h whilst the talcum powder remains in suspension.

NOTE: The 1 min interval between switching on the fan/blower and switching off the luminaire is to ensure that the talcum powder is properly in suspension around the luminaire during initial cooling, which is most important with smaller luminaires. The luminaire is operated initially as in item a) to ensure the test chamber is not overheated.

**Acceptance Conditions:**

After completion of the tests, the luminaire shall withstand the electric strength test specified in Section 10, and inspection shall show:

No deposit of talcum powder inside enclosures for dust-tight luminaires

**Test Result:**

Pass       Fail



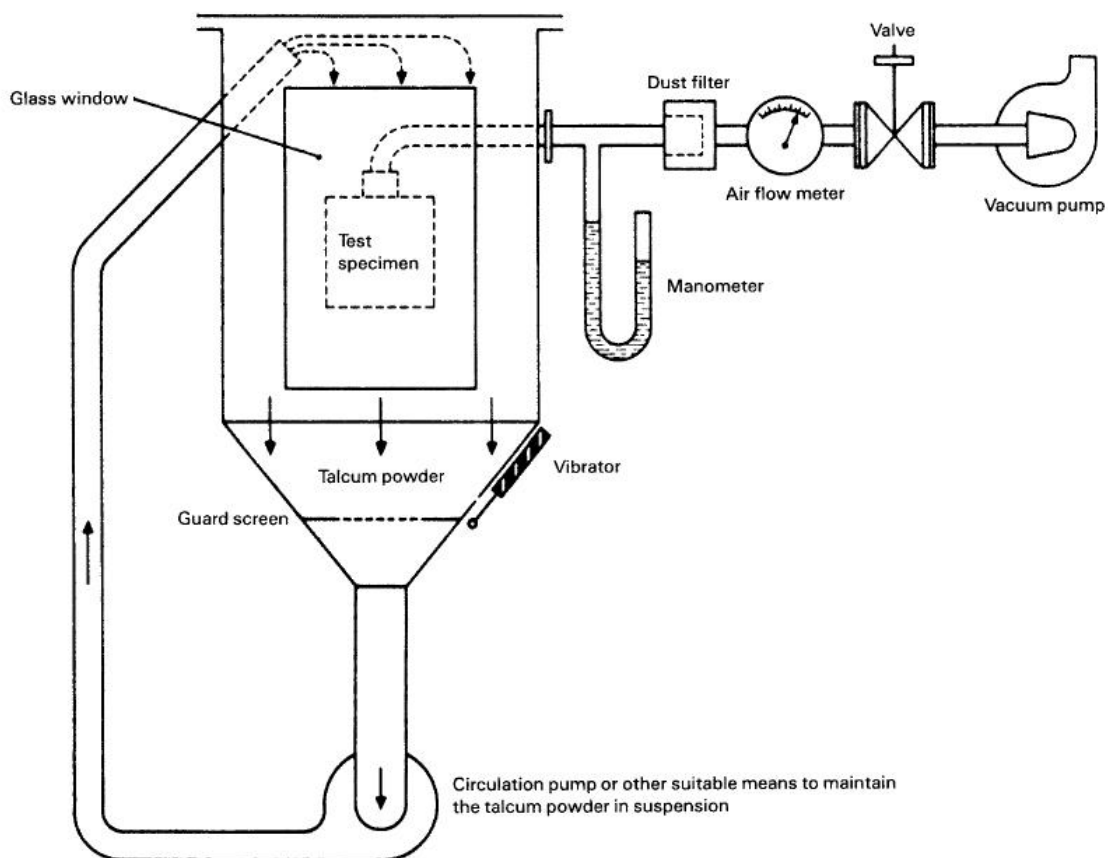

IEC 280/01

NOTE See IEC 60068-2-68, figure 2 valid for La2 only.

**Figure 2 – Test device to verify protection against dust (dust chamber)**



**Test Item:**

Tests for protection against ingress moisture: IPX6

**Test Method:**

The tests should be carried out under the standard atmospheric condition.

Temperature range: 20°C to 30°C

Jet-proof luminaires (second characteristic IP numeral 5) are switched off and immediately subjected to a water jet for 15 min from all directions by means of a hose having a nozzle with the shape and dimensions shown in Figure 8. The nozzle shall be held 3 m away the sample.

The water pressure at the nozzle shall be adjusted to achieve a water flow rate of 12,5 l/min  $\pm$  5 % (approximately 30 kN/m<sup>2</sup>).

Before the tests for the second characteristic numeral, with the exception of IPX8, the luminaire complete with lamp(s) shall be switched on and brought to a stable operating temperature at rated voltage.

The water for the tests shall be at a temperature of 15 °C  $\pm$  10 °C

Luminaires shall be mounted and wired as in normal use and placed in the most unfavourable position, complete with their protective translucent covers, if any, for the tests of IP.

Where connection is made by a plug or a similar device, then this shall be regarded as part of the complete luminaire and shall be included in the tests and similarly for any separate controlgear.

For tests of IP, fixed luminaire intended for mounting with its body in contact with a surface shall be tested with an expanded metal spacer interposed between the luminaire and the mounting surface. The spacer shall be at least equal in overall size to the projection of the luminaire, and have dimensions as follows:

Longway of mesh	10 mm to 20 mm
Shortway of mesh	4 mm to 7 mm
Strand width	1,5 mm to 2 mm
Strand thickness	0,3 mm to 0,5 mm
Overall thickness	1,8 mm to 3 mm

Luminaires having provision for draining water by means of drain holes shall be mounted with the lowest drain hole open unless otherwise specified in the manufacturer's installation instructions.

If the installation instructions indicate that a luminaire is for ceiling or under-canopy mounting, the luminaire shall be attached to the underside of a flat board or plate which extends 10 mm beyond that part of the luminaire perimeter in contact with the mounting surface

For recessed luminaires, the parts in the recess and the parts protruding from the recess shall each be tested according to their IP classification as indicated in the manufacturer's mounting instructions. A box encapsulating the part in the recess may be necessary for the test of IP.

Note: Portable luminaires, wired as in normal use, shall be placed in the most unfavourable position of normal use.

Glands, if any, shall be tightened with a torque equal to two-thirds of that applied to glands in the test of 4.12.5.

Fixing screws of covers, other than hand-operated fixing screws of glass covers, shall be tightened with a torque equal to two-thirds of that specified in Table 4.1.

Screwed lids shall be tightened with a torque having a value in newton metres numerically





equal to one-tenth of the nominal diameter of the screw thread in millimetres. Screws fixing other caps shall be tightened with a torque equal to two-thirds of that specified in Table 4.1.

**Acceptance Conditions:**

After completion of the tests, the luminaire shall withstand the electric strength test specified in Section 10, and inspection shall show:

no trace of water on electrical connections, current carrying parts or on insulation where it could become a hazard for the user or surroundings, for example where it could reduce the creepage distances below the values specified in Section 11; the only exception to this is for SELV conductors where the voltage under load does not exceed 12 V r.m.s. or 30 V ripple free d.c. and the conductors are protected from corrosion.

For luminaires without drain holes, there shall be no water entry.

For luminaires with drain holes, water entry including condensation is allowed during the tests if it can drain out effectively and provided it does not reduce the creepage and clearance distances below the minimum levels specified in the standard.

**Test Result:**

Pass       Fail



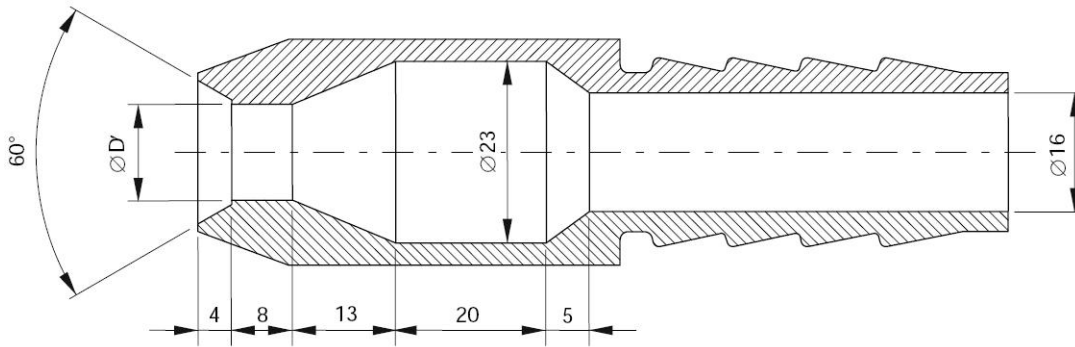

$D' = 6,3$  mm for the test of 9.2.6 (second characteristic numeral 5)  
 $D' = 12,5$  mm for the test of 9.2.7 (second characteristic numeral 6)

Detail of nozzle

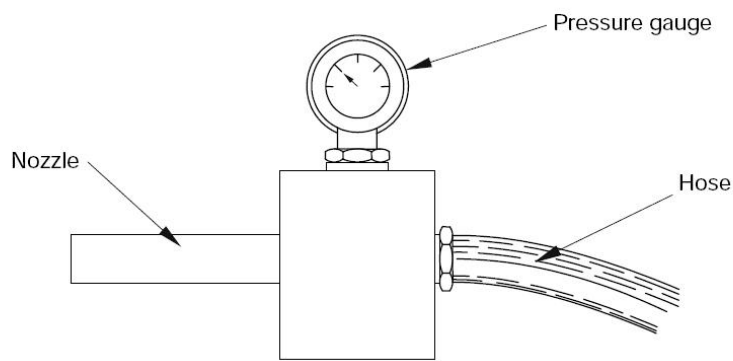

IEC 492/08

Dimensions in millimetres

Figure 8 – Nozzle for spray test





Table 4.1 – Torque tests on screws

Nominal outer thread diameter of screw mm	Torque Nm		
	1	2	3
Up to and including 2,8	0,20	0,40	0,40
Over 2,8 up to and including 3,0	0,25	0,50	0,50
Over 3,0 up to and including 3,2	0,30	0,60	0,50
Over 3,2 up to and including 3,6	0,40	0,80	0,60
Over 3,6 up to and including 4,1	0,70	1,20	0,60
Over 4,1 up to and including 4,7	0,80	1,80	0,90
Over 4,7 up to and including 5,3	0,80	2,00	1,00
Over 5,3 up to and including 6,0	–	2,50	1,25
Over 6,0 up to and including 8,0	–	8,00	4,00
Over 8,0 up to and including 10,0	–	17,00	8,50
Over 10,0 up to and including 12,0	–	29,00	14,50
Over 12,0 up to and including 14,0	–	48,00	24,00
Over 14,0 up to and including 16,0	–	114,00	57,00

Table 4.2 – Torque tests on glands

Diameter of test rod mm	Moment	
	Metal glands Nm	Moulded plastic glands Nm
Up to 7	6,25	2,5
Over 7 up to 14	6,25	3,25
Over 14 up to 20	7,50	5
Over 20	10	7,50

**Withstand the electric strength after IP6X test:**

Test Location	Test Voltage	Broken or Flashover
Live parts and accessible parts	1480V	<input type="checkbox"/> Yes <input checked="" type="checkbox"/> No

**Withstand the electric strength after IPX5 test:**

Live parts and accessible parts	1480V	<input type="checkbox"/> Yes <input checked="" type="checkbox"/> No
---------------------------------	-------	---



**Photo Documentation:**

Photo 1: Front view of model GL-UFO240-N

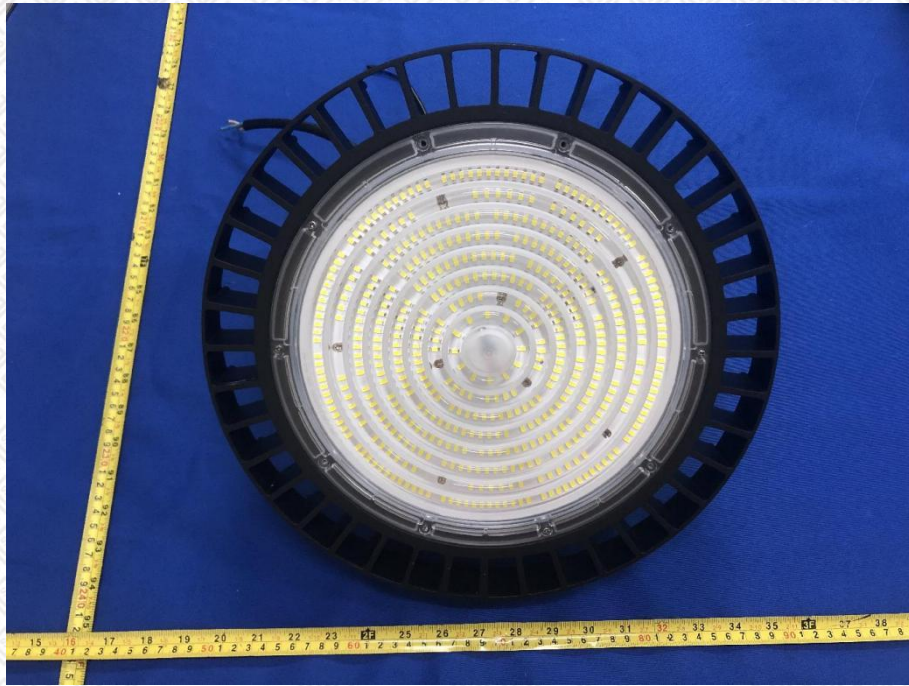
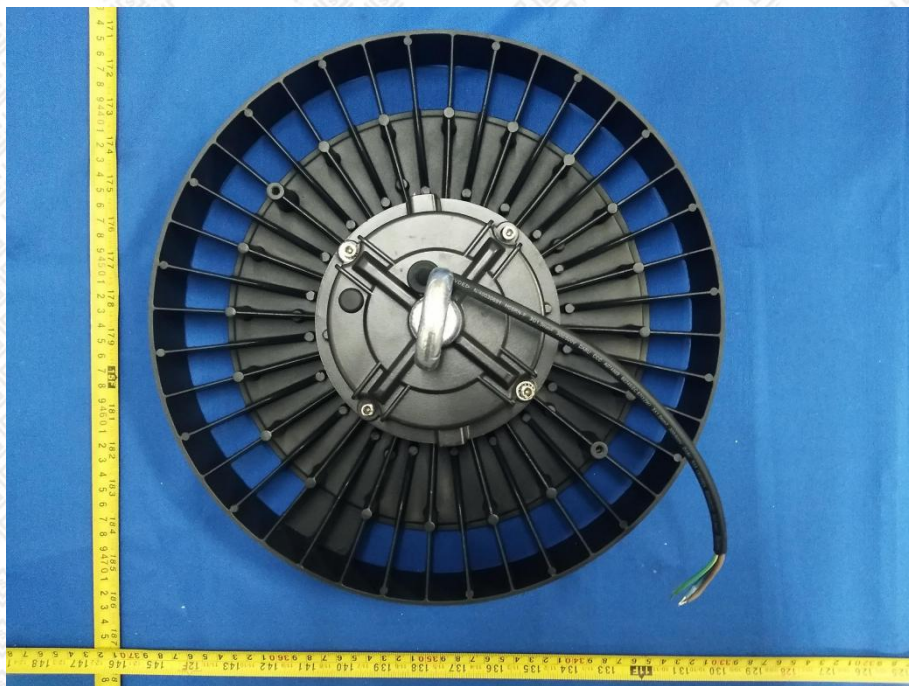

Photo 2: Base view of model GL-UFO240-N



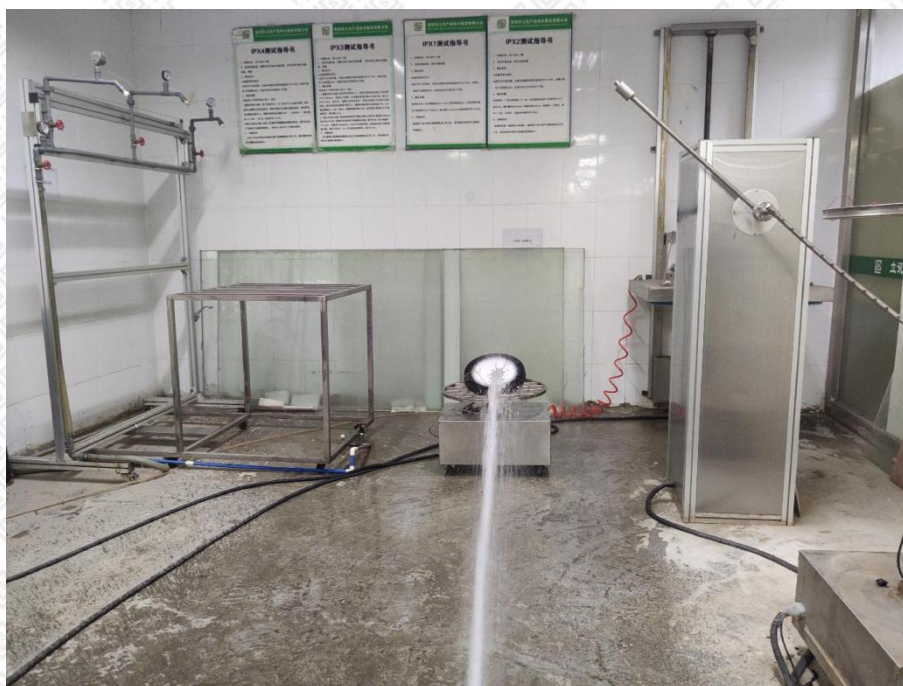

**Photo Documentation:**

Photo 3: IP6X test of model GL-UFO240-N



Photo 4: IPX6 test of model GL-UFO240-N





**Photo Documentation:**

Photo 5: Test result after IP6X and IPX5 test for model GL-UFO240-N

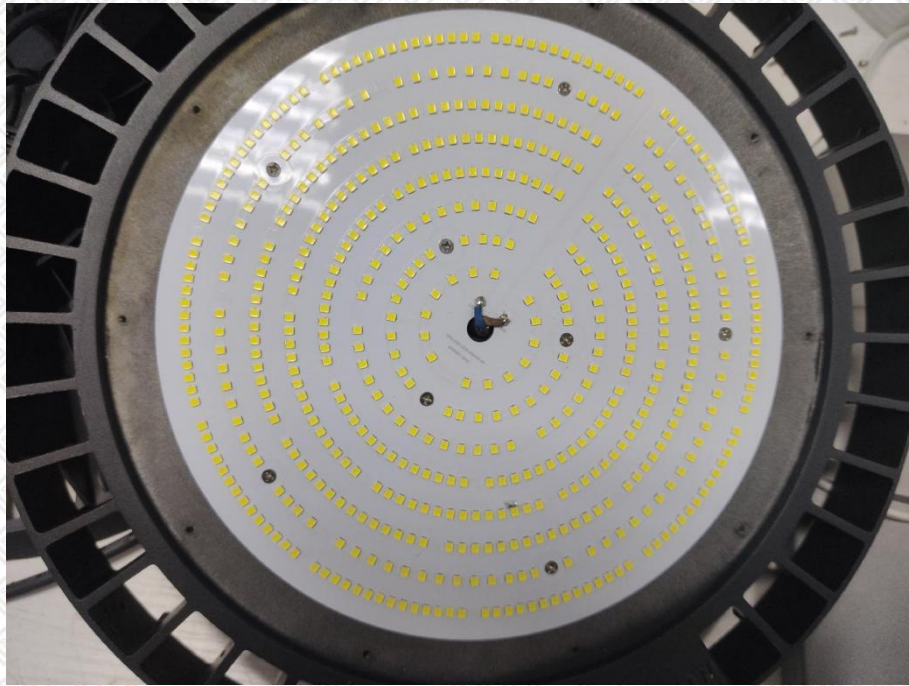
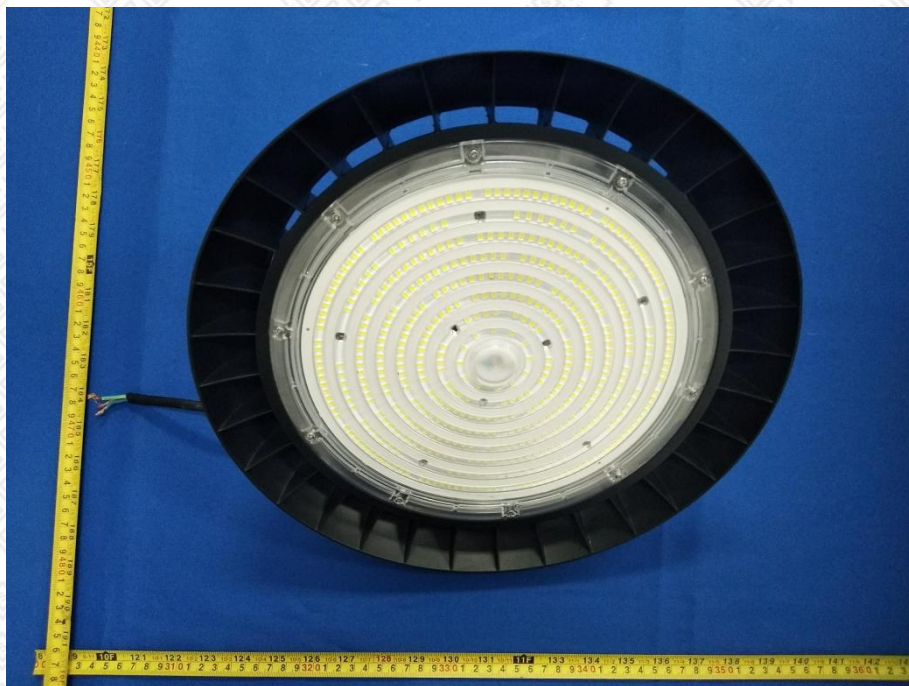

Photo 6: Front view of model GL-UFO200-C





**Photo Documentation:**

Photo 7: Base view of model GL-UFO200-C

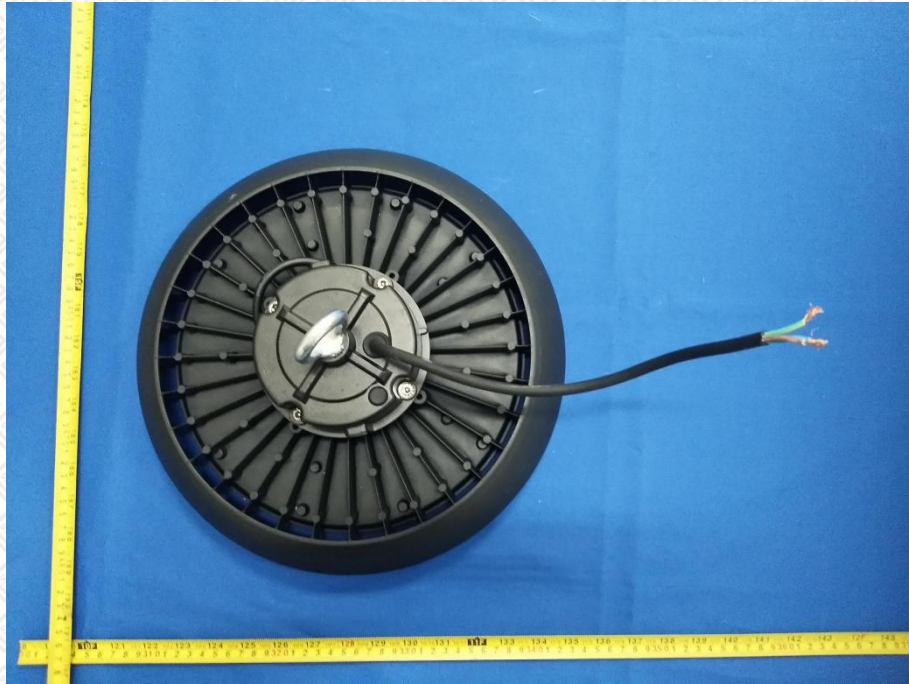

Photo 8: IP6X test of model GL-UFO200-C



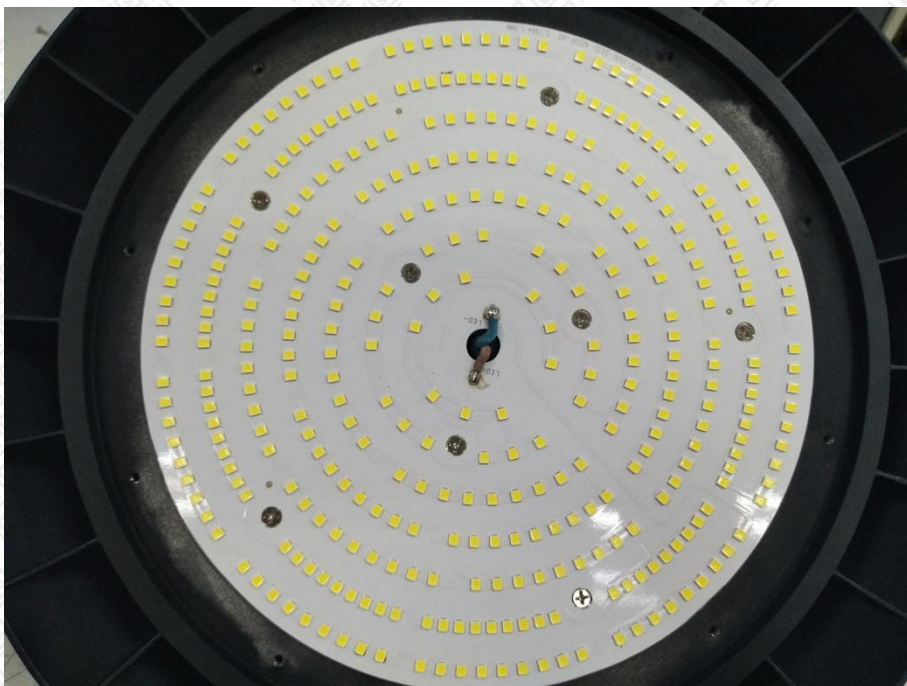

**Photo Documentation:**

Photo 9: IPX6 test of model GL-UFO200-C



Photo 10: Test result after IP6X and IPX5 test for model GL-UFO200-C





**Photo Documentation:**

Photo 11: Front view of model GL-UFO200-K

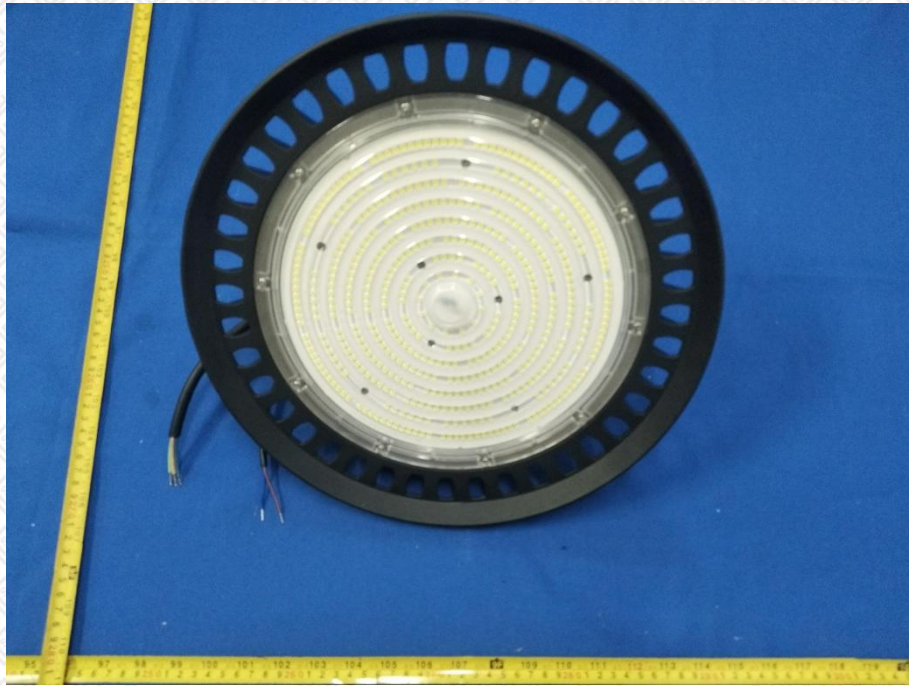
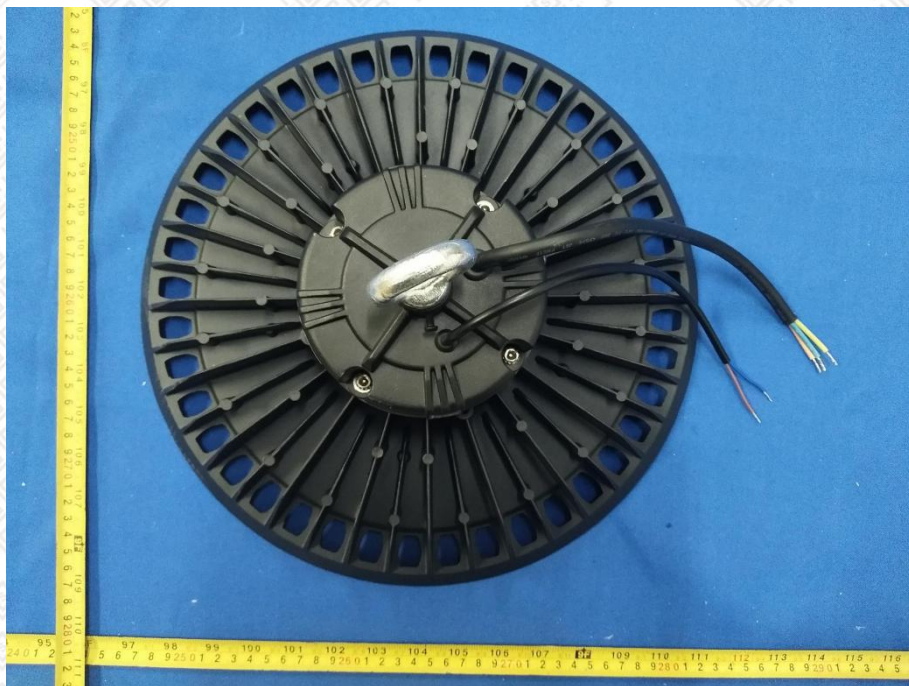

Photo 12: Base view of model GL-UFO200-K





**Photo Documentation:**

Photo 13: IP6X test of model GL-UFO200-K



Photo 14: IPX6 test of model GL-UFO200-K





**Photo Documentation:**

Photo 15: Test result after IP6X and IPX5 test for model GL-UFO200-K

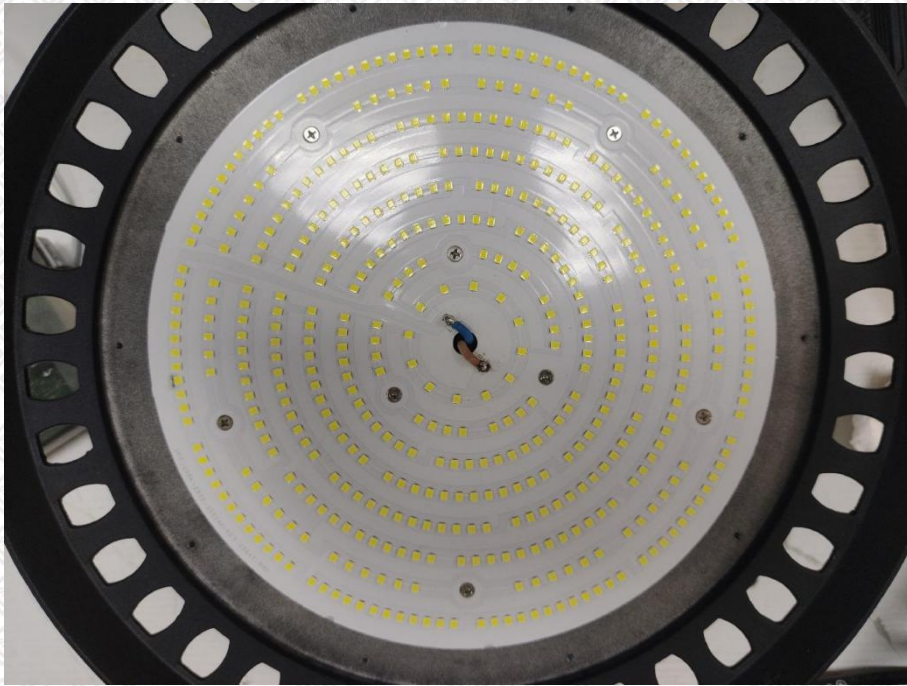

Photo 16: Front view of model GL-UFO500-J





**Photo Documentation:**

Photo 17: Base view of model GL-UFO500-J

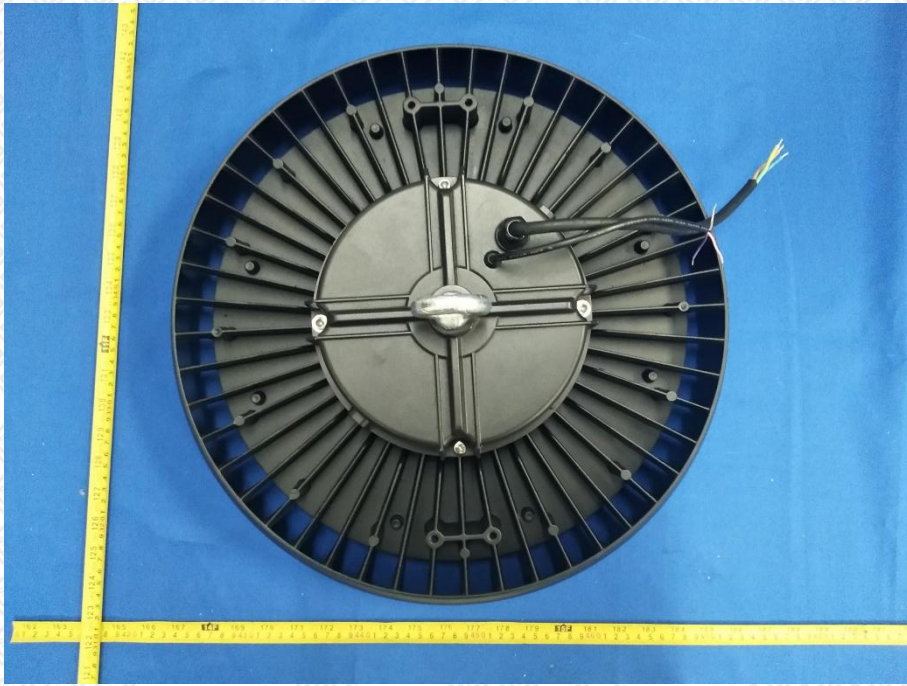

Photo 18: IP6X test of model GL-UFO500-J



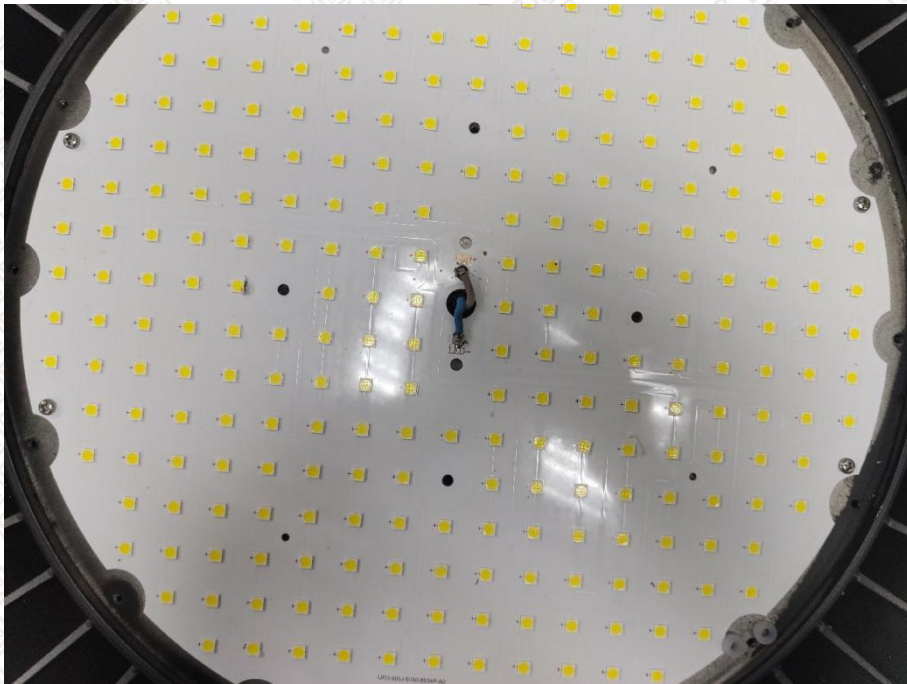

**Photo Documentation:**

Photo 19: IPX6 test of model GL-UFO500-J



Photo 20: Test result after IP6X and IPX5 test for model GL-UFO500-J



----- End of Test Report-----